

Type MLS 125 °C Flatpack, Ultra Long Life, Aluminum Electrolytic

Now Available with High Vibration and High Reliability Options



Encased in rugged stainless steel, the MLS is perfect for high reliability military systems and applications operating above 85 °C. For our highest performing 125 °C Flatpacks, choose type HVMLS available in a special stainless steel case for high vibration applications up to 50g. Specify type HRMLS for high reliability Flatpacks which are subjected to MIL level burn-in processes to ensure established reliability.

Highlights

- Near-hermetic welded seal
- Stainless-steel case
- 100 years expected operating life
- Withstands more than 80,000 feet altitude
- Type HV up to 50g
- Type HR, High Reliability

Specifications

Temperature Range	-55 °C to +125 °C																																																												
Rated Voltage Range	5.0 Vdc to 250 Vdc																																																												
Capacitance Range	220 µF to 47,000 µF																																																												
Capacitance Tolerance	±20%																																																												
Leakage Current	≤ 0.002 CV µA, @ 25 °C and 5 mins.																																																												
Ripple Current Multipliers	<p>Case Temperature</p> <table border="1"> <thead> <tr> <th>45 °C</th> <th>55 °C</th> <th>65 °C</th> <th>75 °C</th> <th>85 °C</th> <th>95 °C</th> <th>105 °C</th> <th>115 °C</th> <th>125 °C</th> </tr> </thead> <tbody> <tr> <td>1.41</td> <td>1.32</td> <td>1.22</td> <td>1.12</td> <td>1.00</td> <td>0.87</td> <td>0.71</td> <td>0.50</td> <td>0.00</td> </tr> </tbody> </table> <p>Ambient Temperature, No Heatsink</p> <table border="1"> <thead> <tr> <th>45 °C</th> <th>55 °C</th> <th>65 °C</th> <th>75 °C</th> <th>85 °C</th> <th>95 °C</th> <th>105 °C</th> <th>115 °C</th> <th>125 °C</th> </tr> </thead> <tbody> <tr> <td>0.63</td> <td>0.58</td> <td>0.54</td> <td>0.49</td> <td>0.44</td> <td>0.38</td> <td>0.31</td> <td>0.22</td> <td>0.00</td> </tr> </tbody> </table> <p>Frequency</p> <table border="1"> <thead> <tr> <th></th> <th>50 Hz</th> <th>60 Hz</th> <th>120 Hz</th> <th>360 Hz</th> <th>1 kHz</th> <th>5 kHz</th> <th>10 kHz & up</th> </tr> </thead> <tbody> <tr> <th>5 to 40 V</th> <td>0.95</td> <td>0.96</td> <td>1.00</td> <td>1.03</td> <td>1.04</td> <td>1.04</td> <td>1.04</td> </tr> <tr> <th>60 to 250 V</th> <td>0.80</td> <td>0.84</td> <td>1.00</td> <td>1.18</td> <td>1.25</td> <td>1.30</td> <td>1.30</td> </tr> </tbody> </table>	45 °C	55 °C	65 °C	75 °C	85 °C	95 °C	105 °C	115 °C	125 °C	1.41	1.32	1.22	1.12	1.00	0.87	0.71	0.50	0.00	45 °C	55 °C	65 °C	75 °C	85 °C	95 °C	105 °C	115 °C	125 °C	0.63	0.58	0.54	0.49	0.44	0.38	0.31	0.22	0.00		50 Hz	60 Hz	120 Hz	360 Hz	1 kHz	5 kHz	10 kHz & up	5 to 40 V	0.95	0.96	1.00	1.03	1.04	1.04	1.04	60 to 250 V	0.80	0.84	1.00	1.18	1.25	1.30	1.30
45 °C	55 °C	65 °C	75 °C	85 °C	95 °C	105 °C	115 °C	125 °C																																																					
1.41	1.32	1.22	1.12	1.00	0.87	0.71	0.50	0.00																																																					
45 °C	55 °C	65 °C	75 °C	85 °C	95 °C	105 °C	115 °C	125 °C																																																					
0.63	0.58	0.54	0.49	0.44	0.38	0.31	0.22	0.00																																																					
	50 Hz	60 Hz	120 Hz	360 Hz	1 kHz	5 kHz	10 kHz & up																																																						
5 to 40 V	0.95	0.96	1.00	1.03	1.04	1.04	1.04																																																						
60 to 250 V	0.80	0.84	1.00	1.18	1.25	1.30	1.30																																																						
Low Temperature Characteristics	<p>Impedance ratio: $Z_{-55^{\circ}\text{C}}/Z_{+25^{\circ}\text{C}}$</p> <p>≤ 10 (5 - 20 Vdc)</p> <p>≤ 2 (25 - 250 Vdc)</p>																																																												
Endurance Life Test	<p>10,000 h @ full load at 85 °C</p> <p>Δ Capacitance ±10%</p> <p>ESR 200% of limit</p> <p>DCL 100% of limit</p>																																																												
DC Life Test	<p>2000 h at rated voltage & 125 °C</p> <p>Δ Capacitance ±10%</p> <p>ESR 200% of limit</p> <p>DCL 100% of limit</p>																																																												
Shelf Life Test	<p>500 h at 125 °C</p> <p>Capacitance 100% of limit</p> <p>ESR 100% of limit</p> <p>DCL 100% of limit</p>																																																												
Vibration	<p>Standard MLS Flatpack: 10g</p> <p>10 Hz to 2 kHz Sine Swept, 0.06" pp max and 10g.</p> <p>Type HVMLS Flatpack 1.5" and 2.0" case length, 50g</p> <p>Type HVMLS Flatpack 2.5" and 3.0" case length, 30g</p> <p>MIL-STD-202, Meth. 204, Sine Swept, IEC 60068-2-6</p>																																																												

Type MLS 125 °C Flatpack, Ultra Long Life, Aluminum Electrolytic

Available with High Vibration and High Reliability Options

Vibration Test	<p>Level The specimens, while deenergized or operating under the load conditions specified, shall be subjected to the vibration amplitude, frequency range, and duration specified for each case size.</p> <p>Amplitude The specimens shall be subjected to a simple harmonic motion having an amplitude of either 0.06-inch double amplitude (maximum total excursion) or peak level specified above (XXg peak), whichever is less. The tolerance on vibration amplitude shall be ±10 percent.</p> <p>Frequency Range The vibration frequency shall be varied logarithmically between the approximate limits of 10 to 2,000 Hz.</p> <p>Sweep Time and Duration The entire frequency range of 10 to 2,000 Hz and return to 10 Hz shall be traversed in 20 minutes. This cycle shall be performed 12 times in each of three mutually perpendicular directions (total of 36 times), so that the motion shall be applied for a total period of approximately 12 hours. Interruptions are permitted provided the requirements for rate of change and test duration are met.</p>																											
High Reliability Test/Burn-in	Established Reliability capacitors shall be subjected to a minimum of 100 percent of the dc rated voltage at 85 °C for 48 hours minimum but not to exceed 96 hours. During this test, capacitors shall be adequately protected against temporary voltage surges of 10 percent or more of the test voltage. After burn-in, the capacitors shall be returned to room ambient conditions and the dc leakage, capacitance, and ESR shall be measured with respect to specified limits.																											
Thermal Resistance	<table border="1"> <thead> <tr> <th rowspan="2">Large Sides Heatsinked</th> <th rowspan="2">Case Length</th> <th>1.5"</th> <th>2.0"</th> <th>3.0"</th> </tr> <tr> <th>Insulation</th> <th>°C/W</th> <th>°C/W</th> <th>°C/W</th> </tr> </thead> <tbody> <tr> <td rowspan="2">one</td> <td>None</td> <td>4.3</td> <td>3.1</td> <td>2.0</td> </tr> <tr> <td>Polyester</td> <td>4.7</td> <td>3.4</td> <td>2.2</td> </tr> <tr> <td rowspan="2">both</td> <td>None</td> <td>2.8</td> <td>2.0</td> <td>1.3</td> </tr> <tr> <td>Polyester</td> <td>3.0</td> <td>2.2</td> <td>1.4</td> </tr> </tbody> </table>	Large Sides Heatsinked	Case Length	1.5"	2.0"	3.0"	Insulation	°C/W	°C/W	°C/W	one	None	4.3	3.1	2.0	Polyester	4.7	3.4	2.2	both	None	2.8	2.0	1.3	Polyester	3.0	2.2	1.4
Large Sides Heatsinked	Case Length			1.5"	2.0"	3.0"																						
		Insulation	°C/W	°C/W	°C/W																							
one	None	4.3	3.1	2.0																								
	Polyester	4.7	3.4	2.2																								
both	None	2.8	2.0	1.3																								
	Polyester	3.0	2.2	1.4																								
ESL	≤30 nH measured 1/4" from case at 1 MHz																											
Weight	Case EK 43 g typical Case EA 76 g typical Case EB 92 g typical																											
Terminals	18 AWG copper wire with 60/40 tin-lead electroplate, 20 amps max																											
Ripple Current Capability	The ripple current capability is set by the maximum permissible internal core temperature, 125 °C.																											
Air Cooled	The ripple currents in the ratings tables are for 85 °C case temperatures. For air temperatures without a heatsink use the multipliers Ambient Temperature, No Heatsink.																											
Heatsink Cooled	Temperature rise from the internal hottest spot, the core, to ambient air is $\Delta T = I^2(ESR)(\theta_{cc} + \theta_{ca})$ where θ_{cc} is the thermal resistance from core to case and θ_{ca} from case to ambient. To calculate maximum ripple capability with the MLS attached to a heatsink use the maximum core temperature and the values for θ_{cc} .																											
Example	As an illustration, suppose you operate an insulated MLS332M060EB1C in 65 °C air and attach it to a commercial heatsink with a free-air thermal resistance of 2.7 °C/W. Use a good thermal grease between the MLS and the heatsink, and the total thermal resistance is 2.7 + 1.8 or 4.5 °C/W. The power which would heat the core to 125 °C is (125 - 65)/4.5 or 13.3 W. For an ESR of 31 mΩ, 13.3 W equates to a ripple current of 20.7 A, however, the wire leads are rated for only 20 A.																											

Type MLS 125 °C Flatpack, Ultra Long Life, Aluminum Electrolytic

Available with High Vibration and High Reliability Options

Part Numbering System

HV	HR	MLS	821	M	200	EB	0	A
Optional High Vibration	Optional High Reliability	Type MLS	Capacitance 821=820 μ F 102 = 1000 μ F	Tolerance M= \pm 20%	Rated Voltage Vdc	Case Code EK, L=1.5 in. EA, L=2.0 in. EB, L=3.0 in. * other sizes available	Insulation 0 = bare can 1 = polyester	Mounting Style A = mounting tabs C = two leads/no tabs D = hook leads/tabs * other mounting tab options available

Examples:
 Standard MLS: MLS821M200EB0C
 High Reliability: HRMLS821M200EB0C
 High Vibration: HVMLS821M200EB0C
 High Reliability, High Vibration: HVHRMLS821M200EB0C

Outline Drawings

Note: The polyester tape wrap may add up to 0.020 inches to the thickness and width of the capacitor.

Standard Type MLS

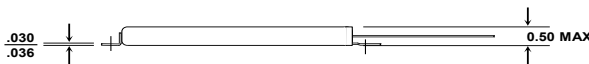

Type HV, Rilled Construction

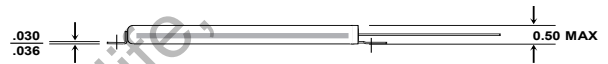

Style A: Mounting Tabs

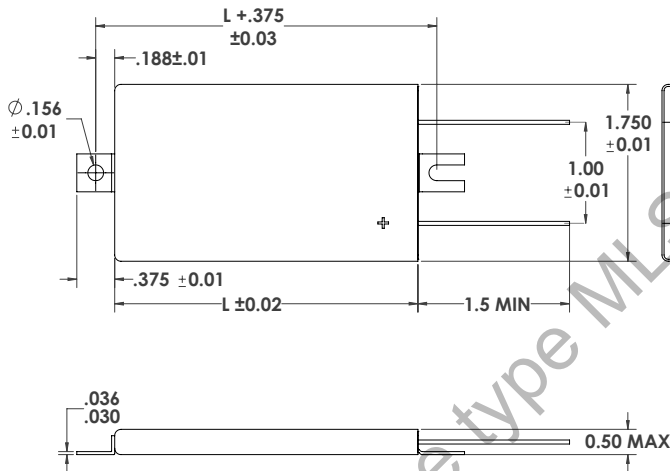

Style C: No Tabs

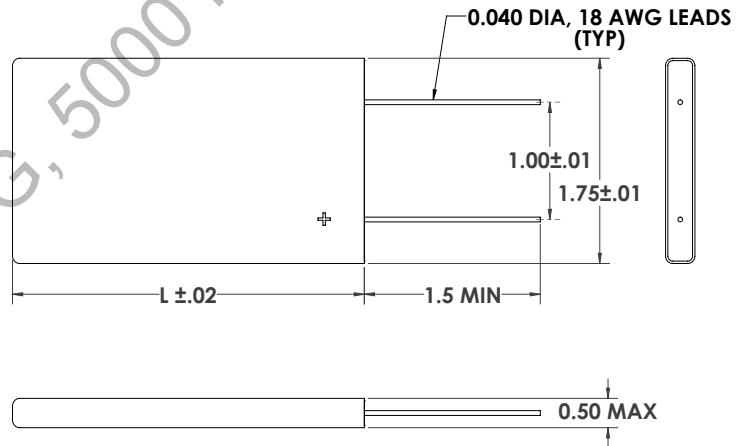

Style D: Hook Leads

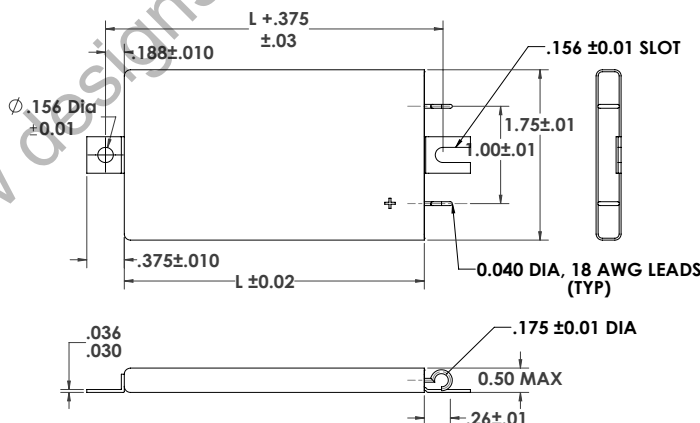

Case Code	Length L (in)	Weight (g)
EK	1.5	43
EA	2.0	76
EB	3.0	92

Mounting tabs are welded to the case.

Type MLS 125 °C Flatpack, Ultra Long Life, Aluminum Electrolytic

Available with High Vibration and High Reliability Options

Ratings

Cap (μ F)	Catalog Part Number	ESR max 25 °C (m Ω)		Ripple (A) Case @ 85°C		Length (inches)
		120 Hz	20 kHz	120 Hz	20 kHz	
125 °C: 5 Vdc, 105 °C: 7.5 Vdc, 25 °C Surge: 10 Vdc						
19,000	MLS193M5R0EK0C	76	66	11.6	12.5	1.5
28,000	MLS283M5R0EA0c	50	44	14.3	15.4	2.0
47,000	MLS473M5R0EB0C	30	26	18.5	19.9	3.0
125 °C: 7.5 Vdc, 105 °C: 10 V, 25 °C Surge: 13 Vdc						
17,000	MLS173M7R5EK0C	77	67	11.5	12.4	1.5
26,000	MLS263M7R5EA0c	51	45	14.1	15.1	2.0
43,000	MLS433M7R5EB0C	31	27	18.2	19.5	3.0
125 °C: 10 Vdc, 105 °C: 16 V, 25 °C Surge: 20 Vdc						
13,000	MLS133M010EK0C	81	69	11.3	12.2	1.5
23,000	MLS233M010EA0C	51	45	14.0	15.0	2.0
38,000	MLS383M010EB0C	31	27	18.2	19.5	3.0
125 °C: 20 Vdc, 105 °C: 30 V, 25 °C Surge: 40 Vdc]						
6,800	MLS682M020EK0C	84	69	11.0	12.2	1.5
10,000	MLS103M020EA0C	56	46	13.6	15.0	2.0
17,000	MLS173M020EB0C	33	27	17.6	19.5	3.0
125 °C: 40 Vdc, 105 °C: 50 V, 25 °C Surge: 63 Vdc						
4,400	MLS442M040EK0C	97	70	10.3	12.1	1.5
6,600	MLS662M040EA0C	62	46	12.9	15.0	2.0
11,000	MLS113M040EB0C	36	27	16.9	19.5	3.0
125 °C: 60 Vdc, 105 °C: 80 V, 25 °C Surge: 100 Vdc						
1,500	MLS152M060EK0C	106	77	9.8	11.5	1.5

Cap (μ F)	Catalog Part Number	ESR max 25 °C (m Ω)		Ripple (A) Case @ 85°C		Length (inches)
		120 Hz	20 kHz	120 Hz	20 kHz	
2,100	MLS212M060EA0C	72	52	11.9	14.1	2.0
3,300	MLS332M060EB0C	44	31	15.3	18.2	3.0
125 °C: 75 Vdc, 105 °C: 100 V, 25 °C Surge: 125 Vdc						
1,100	MLS112M075EK0C	112	78	9.6	11.5	1.5
1,600	MLS162M075EA0C	76	54	11.6	13.8	2.0
2,700	MLS272M075EB0C	46	33	14.9	17.6	3.0
125 °C: 100 Vdc, 105 °C: 150 V, 25 °C Surge: 180 Vdc						
500	MLS501M100EK0C	355	248	5.4	6.4	1.5
770	MLS771M100EA0C	238	166	6.6	7.8	2.0
1,300	MLS132M100EB0C	143	100	8.5	10.1	3.0
125 °C: 150 Vdc, 105 °C: 200 V, 25 °C Surge: 250 Vdc						
400	MLS401M150EK0C	388	253	5.1	6.4	1.5
600	MLS601M150EA0C	261	168	6.3	7.8	2.0
1,000	MLS102M150EB0C	158	100	8.1	10.1	3.0
125 °C: 200 Vdc, 105 °C: 250 Vdc, 25 °C Surge: 300 Vdc						
330	MLS331M200EK0C	426	258	4.9	6.2	1.5
490	MLS491M200EA0C	285	172	6.0	7.7	2.0
820	MLS821M200EB0C	172	103	7.7	10.0	3.0
125 °C: 250 Vdc, 105 °C: 250 Vdc, 25 °C Surge: 300 Vdc						
220	MLS221M250EK0C	597	393	4.1	5.1	1.5
330	MLS331M250EA0C	399	262	5.0	6.3	2.0
560	MLS561M250EB0C	240	157	6.5	8.1	3.0

Typical Performance Curves

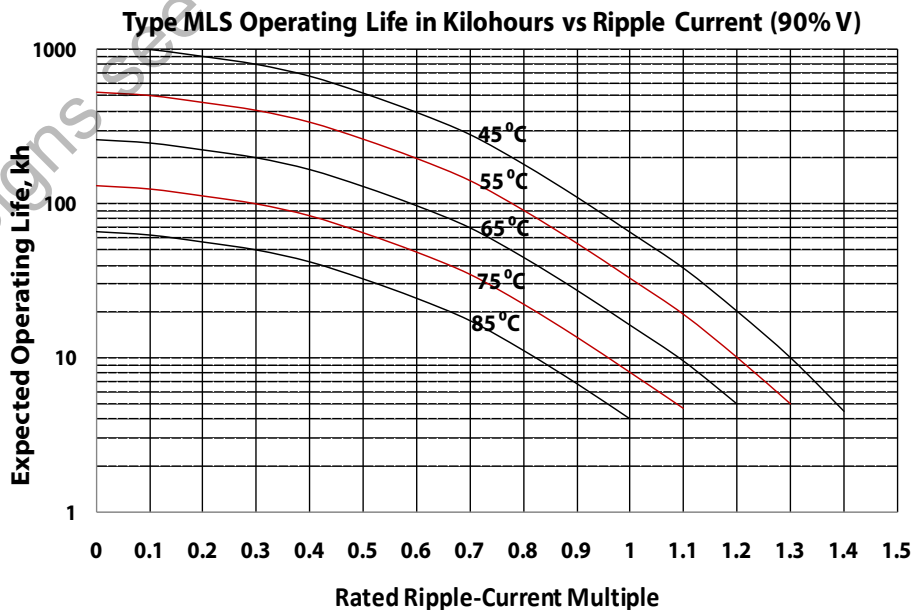

Type MLS 125 °C Flatpack, Ultra Long Life, Aluminum Electrolytic

Available with High Vibration and High Reliability Options

Typical Performance Curves

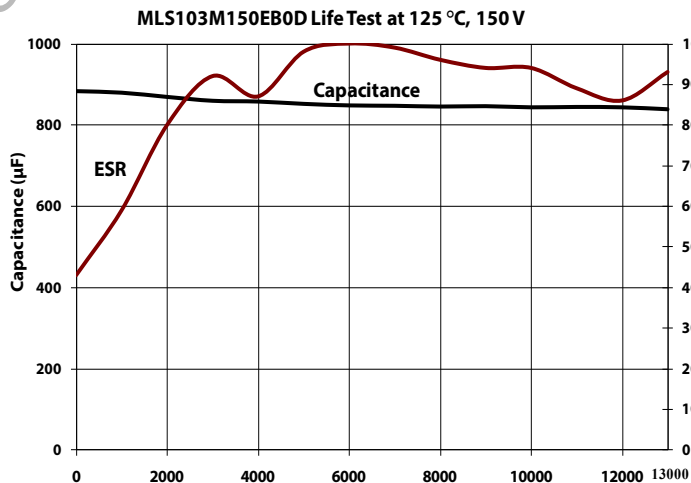
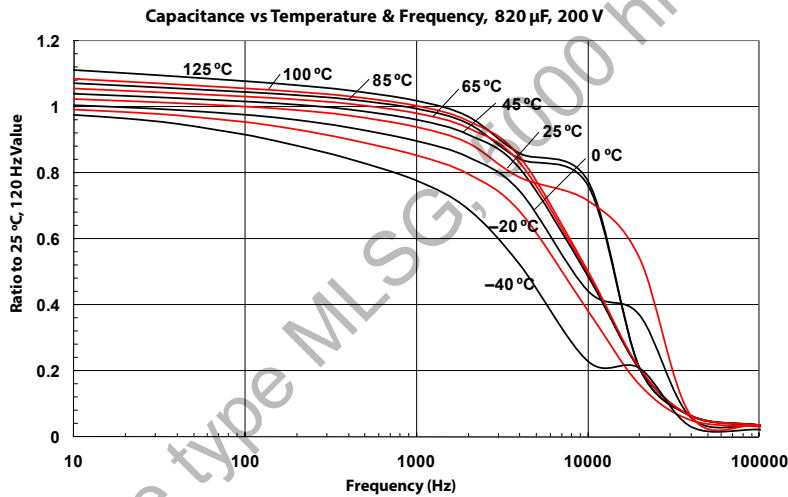
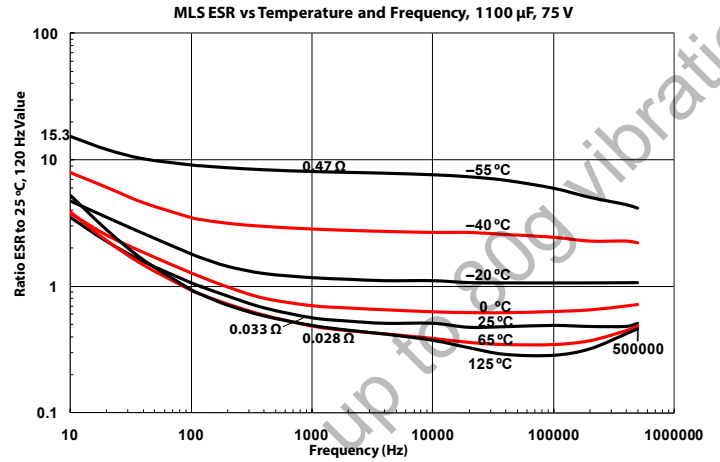
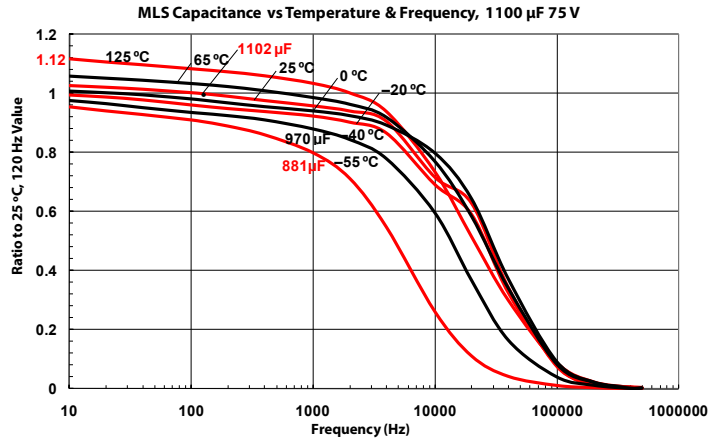

Notice and Disclaimer: All product drawings, descriptions, specifications, statements, information and data (collectively, the "Information") in this datasheet or other publication are subject to change. The customer is responsible for checking, confirming and verifying the extent to which the Information contained in this datasheet or other publication is applicable to an order at the time the order is placed. All Information given herein is believed to be accurate and reliable, but it is presented without any guarantee, warranty, representation or responsibility of any kind, expressed or implied. Statements of suitability for certain applications are based on the knowledge that the Cornell Dubilier company providing such statements ("Cornell Dubilier") has of operating conditions that such Cornell Dubilier company regards as typical for such applications, but are not intended to constitute any guarantee, warranty or representation regarding any such matter – and Cornell Dubilier specifically and expressly disclaims any guarantee, warranty or representation concerning the suitability for a specific customer application, use, storage, transportation, or operating environment. The Information is intended for use only by customers who have the requisite experience and capability to determine the correct products for their application. Any technical advice inferred from this Information or otherwise provided by Cornell Dubilier with reference to the use of any Cornell Dubilier products is given gratis (unless otherwise specified by Cornell Dubilier), and Cornell Dubilier assumes no obligation or liability for the advice given or results obtained. Although Cornell Dubilier strives to apply the most stringent quality and safety standards regarding the design and manufacturing of its products, in light of the current state of the art, isolated component failures may still occur. Accordingly, customer applications which require a high degree of reliability or safety should employ suitable designs or other safeguards (such as installation of protective circuitry or redundancies or other appropriate protective measures) in order to ensure that the failure of an electrical component does not result in a risk of personal injury or property damage. Although all product-related warnings, cautions and notes must be observed, the customer should not assume that all safety measures are indicated in such warnings, cautions and notes, or that other safety measures may not be required.

For new designs see type MMSG, <http://www.cdb.com>