

Metallized Film Capacitors Keep Pace With High-Voltage IGBT Modules

IGBT modules now achieve blocking voltages of 6kV or higher, so dc capacitors of 1 μ F to 100 mF at 3.3kV are used for the associated dc bus. Different capacitor technologies have been used for these applications, including aluminum electrolytic, oil or gas impregnated metallized film, or metallized paper. Ideally, a single capacitor should be able to operate continuously with an extended life of over 100,000 hours at these dc bus voltages.

Before 1990, high voltage dc filter capacitors used metallized paper impregnated with wax or multiple computer grade aluminum electrolytics in series. Metallized paper, although selfhealing, allowed gas to generate. Aluminum electrolytics had the problem of not being able to handle certain surge conditions because too high a voltage caused a breakdown in its oxide, resulting in an internal short circuits^[2].

Since 1990, metallized paper was replaced with polypropylene film and the metallization was not only self-healing yet allowed a way to insert an accurate protection system within the capacitor. This latest technology with patterned electrodes allows control of the energy involved in an internal breakdown that becomes a beneficial self-healing^[3]. These advancements have allowed a 50% reduction in capacitor size, with about half of this volumetric change in the last 23 years.

Performance of the new 3300Vdc dielectric system is exhibited by its aging characteristics under normal operating conditions and the safe failure mode of capacitance reduction caused by severe duty or end of life. This performance is demonstrated by applications where it is generally considered that a 2% reduction in capacitance from

A single, self-protected, metallized polypropylene capacitor can operate at 3.3kVdc continuously and have an extended life of 100,000 hours or greater.

the original measured value is what defines end of life for at least 20 years at or near continuous duty^[3,4].

Construction Economics

The application range of the high voltage IGBT (HVIGBT) has been stated to be for ac line voltages up to 4.16kV^[5]. Some of these

applications require a bus voltage above the blocking voltage of a single HVIGBT, so multiple levels of voltage are applied in series, with each level having a bus voltage of the total divided by the number of levels. If the 4.16kVac example is used line-to-line, then each nominal dc bus level is a portion of the 5.883kV total. For example, if three levels are employed, then a dc bus of less than 2kV is applicable and a 3.3kV semiconductor blocking voltage is suitable.

Today, there are IGBTs with blocking voltages above 3.3kV, and IGCTs (Integrated Gate Control Thyristors) are achieving 4.5kV in prototypes and 6.0kV devices are within sight^[6]. These new developments will make a dc bus practical at 3.3kV.

In nonstationary high voltage converters, such as locomotives, metallized film capacitors with patterned electrodes are widely used^[3]. In other stationary applications the choice between the film dielectric and electrolytic technologies depends on criteria such as abnormal working conditions, end of life, dimensions, and cost for the whole filtering function^[2]. The electrolytic capacitor has been widely used because of its high capacitance for its size and low price. However, the electrolytic capacitor, when employed, usually has the shortest life span of any component in the power supply^[7]. Until recently, there has not been an adequate alternative of extended life and reason-

Metallized Film Capacitors

able dimensions that does not increase filtering cost. However, several factors are changing the economics of film vs. electrolytics:

- 1) The energy density increase of film capacitors has greatly reduced their size.
- 2) The reduction in film capacitor size has greatly reduced their cost.
- 3) The newer semiconductors now allow fewer series voltage levels in some applications. In these applications a single film capacitor replaces several series connected aluminum electrolytics (*Figure 1*).
- 4) A single film capacitor with a ripple current rating of 300 to 600A can replace 10 to 30 of the series wired groups in parallel (*Figure 2*).

3300Vdc Film Capacitor

The new type WA film capacitor is a selfprotected metallized polypropylene type in a welded aluminum case, which allows operation in magnetic fields generated by higher frequency operation. Often, stainless steel is substituted and serves a similar purpose. Terminal arrangements are made on the top of the capacitor to allow the parallel connection of several internal capacitor elements and a reduction in the series inductance. *Figure 3* shows a 1000 μ F, 3.3kVdc capacitor with eight terminals. This capacitor has a base of 34.3 cm x 15.0 cm and is 38 cm high. *Figure 4* illustrates the capacitor's configuration with four individual capacitors.

Internally, these capacitors consists of a metallized thin film (usually 520 μ m) with a thin aluminum layer or another metal, such as an alloy of aluminum with zinc. The metallization layer is usually about 250 Å thick, making it less than 0.5% of the film thickness, so it has a negligible effect on capacitor size. The metallization is deposited on one end, called the margin, to prevent flashover. Two of these like metallized films are wound together with the margins in opposite

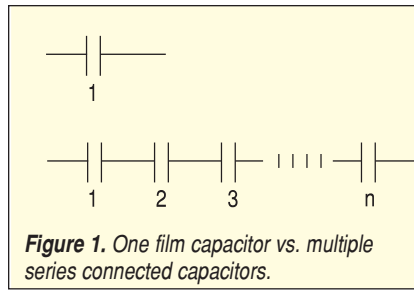

Figure 1. One film capacitor vs. multiple series connected capacitors.

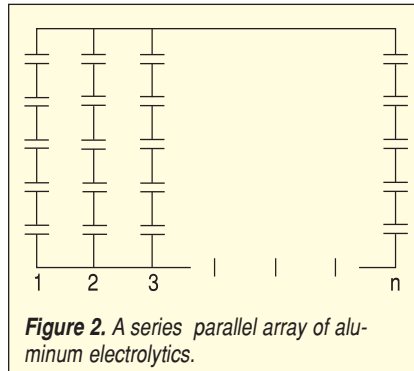

Figure 2. A series parallel array of aluminum electrolytics.



Figure 3. Film Capacitor 1000 μ F, 3.3kVdc.

directions to achieve a capacitance of a given value.

This metallized construction not only reduces its size, but is selfhealing. That is, if a breakdown occurs, the thin metallic electrode in the vicinity of the fault is vaporized and turned from a metal conductor into a metal oxide insulator. In film dielectrics, successful selfhealing of the puncture depends upon the energy released and the quantity of carbon deposited in the isolation region^[10]. Control of the energy is critical to not

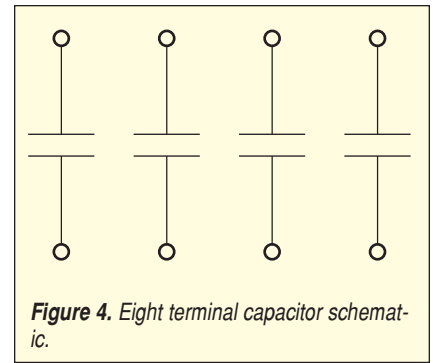

Figure 4. Eight terminal capacitor schematic.

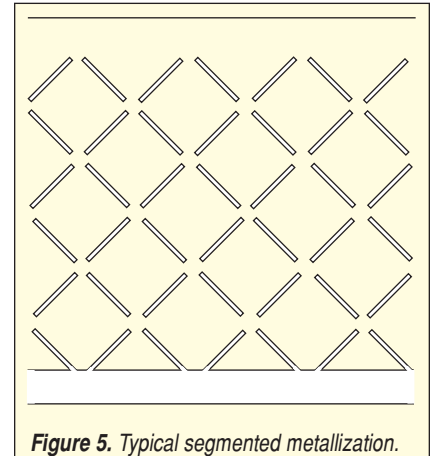

Figure 5. Typical segmented metallization.

inducing additional faults and self-healing in an avalanche type process. The metal electrode thickness is selected to control the energy on vaporization without reducing current handling and accelerating capacitance loss.

In this 3.3kVdc capacitor, metallization consists of individual segments connected by narrow current gates (*Figure 5*). If one of the segments breaks down, the gates serve as fuses. Therefore, the damage to the capacitor is localized and the capacitance decreases only slightly while protecting the capacitor against complete destruction^[11]. *Figure 6* shows two gates of a segmented electrode that were closed by the energy from a selfhealing event.

Metallized film is wound with a machine that makes a large capacitor element with a rectangular cross section. This increases the capacitor's package density by allowing multiples of these rectangular shaped elements to be stacked with little wasted volume^[10]. It is critical that this type of film capacitor winding is made on a

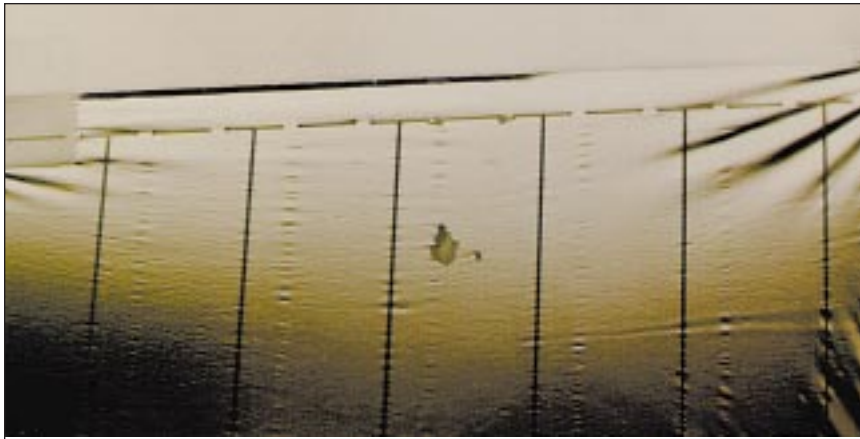

Figure 6. Operation of segmented electrode. (a). Dielectric puncture is in foreground (b). Two closed segmented fuses above.

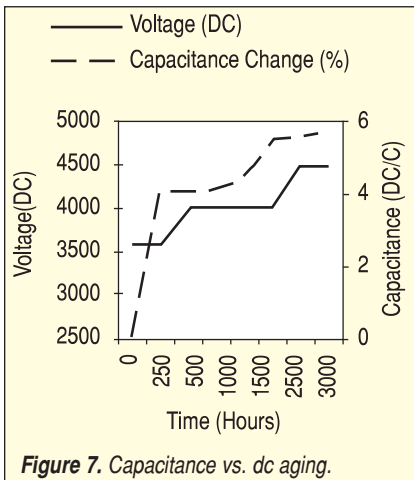

Figure 7. Capacitance vs. dc aging.

device that provides uniform termination regions on the ends of the wound elements. This is accomplished by maintaining a fixed offset between the two wound films that is large enough to increase the surface area and small enough to prevent the termination from breaking. Machines required that wind this type of capacitor maintain this type of uniformity even at high speeds.

The final capacitor is impregnated with rapeseed oil, also commonly referred to as vegetable oil or Canola oil, which is classified as non-hazardous. Its flash point is greater than 350°C, making any hazardous situations a low probability. The rapeseed oil acts to prevent glow discharges within the capacitor windings. It has been shown that an improvement in breakdown strength of approximately 25% can be attributed to diffusion of the oil into the polypropylene film.

With this diffusion, the polypropylene structure and the electrical field becomes more uniform resulting in the breakdown improvement^[11]. Rapeseed oil is also a good conductor of heat, so it allows higher selfheating from ripple currents to be transferred to the capacitors surface.

The internal rectangular capacitor elements for this design are stacked so that the current paths for each element are approximately equal with respect to the terminals. All connections to the terminals are made with bus geometries to minimize self inductance. The can is a welded aluminum construction that is rugged, allows additional heat transfer to the surface and allows operation at even high frequencies such as 200400kHz.

Testing

The new 3.3kVdc capacitor was characterized for tests, including aging under accelerated temperature and voltage conditions, selfheating with 10kHz ripple voltage, and a stepwise voltage stress to verify the capacitor's selfprotection feature.

Seven capacitor samples were fabricated with the metallized dielectric film chosen for 3.3kdc operation. They were 40μF nominal and each used two large rectangular internal elements typical of the construction. The final units were soaked at 85°C without voltage for 24 hours prior to starting the test.

Testing was performed at 85°C

with a dc voltage that was stepwise increased from 3.5kVdc to 4.5kVdc over 3000 hours. The 85°C temperature was chosen as a typical maximum temperature for certain types of electronic components. This allows reasonable acceleration factors to determine estimated lifetimes in usual maximum operating specifications for this type of capacitor, such as 55° 70°C. There is a considerable downward slope in the dielectric strength of the metallized polypropylene with or without the rapeseed oil impregnation at about 50°C and another fall-off starts at about 80°C^[11]. Therefore, there has been a concern that a life test at 85°C could severely understate the life expectancy. One goal in testing was to prevent overstating the life by inducing sufficient aging stress on the adhesion of the electrode with respect to the dielectric film and the metallic termination to the end of the wound capacitor elements.

It was determined that only the capacitance value increased over the 3000hour period, as shown in *Figure 7*. This capacitance increase occurred at the start of testing due to electrostatic compression of the capacitor layers^[3]. This corresponds to a decrease in the gaps between adjacent electrodes in the wound capacitor elements that would normally increase the capacitance. What was of interest is not only did it occur at the start of testing, yet additional increases occurred after the voltage was stepped up further from 3.5kV to 4.0kV and again as the voltage was stepped from 4.0kV to 4.5kV after 2000 hours of testing. The dissipation factor during the testing was also monitored and although it went up about 20% during intermediate test intervals, it had dropped to its original value at the end of 3000 hours. Therefore little aging was observed after 3000 hours at substantially accelerated conditions on the 3.3kV design, including the final 1000 hours testing at 36% over nominal voltage.

The thermal stability test provides

Metallized Film Capacitors

information concerning the capacitors as described in IEC 10711^[12].

- It determines the thermal stability of the capacitor under overload conditions.
- It conditions the capacitor to enable a reproducible loss measurement to be made.

The thermal stability test was run by wiring the 1000 μ F, 3.3kVdc sample capacitor in a parallel resonant circuit with a water-cooled variable inductor and a power inverter. The inverter used is the type commonly used for induction heating, so it had a voltage range starting at about 500Vrms at 10kHz.

The ripple voltage needed to generate the currents of interest for the 3.3kVdc sample at 10kHz was much smaller than the 500Vrms on the inverter. Therefore, a 9.8 μ F capacitor with water cooling was wired in series with the test sample. This series capacitance circuit allowed the correct ripple voltages to be seen across the capacitor.

Voltage in the resonant circuit was increased in steps and the capacitor ripple voltage at 10kHz was monitored on an oscilloscope. The current was obtained by Ohm's Law. The ambient temperature was monitored in the test area in addition to the temperature on the capacitor's cover and on both sides. The current on the capacitor was increased stepwise in 30A steps starting at 300 until a reasonable maximum current rating of 600Arms was obtained. At the lower steps the dwell time was 9 hours per step with the capacitor at rest at night. At the 600Arms step the capacitor was run continuously for 48 hours to determine its thermal stability.

The current steps and their temperature measurements for the thermal stability test are in *Figure 8*. After the completion of the 600A step, the ripple current was increased to 630A for an additional nine hours and the temperature measurements were

made at the end of this period. The theoretical current rating for the sample of 600Arms was based on an ambient temperature of 55°C and a permitted maximum temperature rise of 20°C.

It was desirable that the hot spot be below 80°C with a 5°C safety margin. At 25° ambient and 600Arms, the highest temperature was 45°C on the capacitor cover near the terminals. The cover would normally be expected to have a higher temperature because that is where the inner connections carry the heat. At 630Arms it can be seen that the selfheating has started to accelerate.

Segmented film selfprotection is important for safety reasons and to increase the energy density of the 3.3kVdc capacitor. It was desirable to determine at what voltage the capacitance loss due to selfheating and the closing of the current gates in the segmented pattern would accelerate. This has previously been demonstrated using a similar selfprotected metallized polypropylene design^[2]. In the previous evaluation, a total loss of capacitance was seen after one hour at 3X rated voltage at 80°C. It was also stated that swelling of the can would start after about 30% capacitance loss.

An evaluation determined the general surge capability of the capacitor at 1.5 times the rated voltage at 23°C and also what level, exceeding the 150% of rated voltage, pressure might start to build up in the can. This test was performed by using two samples of the 1000 μ F, 3.3kVdc capacitor. Because each of these samples had four independent capacitors in parallel, it provided eight individual measurements during the testing.

The IEC 10711 specification dictates certain levels for surge capabilities of power electronic capacitors. It states that those surge levels over 110% of rated voltage are based upon no significant reduction in life. It is believed that the studied construction does not really care how much of the surge is in one day, but really the

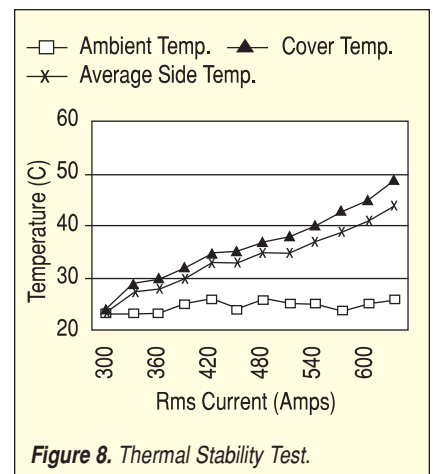

Figure 8. Thermal Stability Test.

total time at that level over the normal rated life of the capacitor. These surge levels include:

- 110% of rated voltage 30% of onload duration
- 115% of rated voltage 30 minutes per day
- 120% of the rated voltage 5 minutes per day
- 130% of rated voltage 1 minute per day
- 150% of rated voltage 100 msec per day

The accelerated aging evaluation clearly demonstrated capabilities up to 136% of rated voltage at 85°C. The test of the selfprotection feature was therefore started at 150% of rated voltage and stepped in increments of 25% of rated voltage. During this testing, pressure switches designed to open at 10 \pm 1 psi were installed in the capacitors in series with the voltage source. The step at 150% of rated voltage was for 100 hours and subsequent steps at 175% and 200% of the rated voltage were for 10 hours per step. The final step at 225% of the rated voltage was run until the capacitances were reduced to approximately 50% of their original measured values. The capacitance variation during this test is shown in *Figure 9*.

The selfprotection feature of the design was clearly demonstrated, although some capacitance reduction was observed at 175% of the rated voltage, substantial degradation did not start until 200% of the rated voltage. The capacitance loss accelerated

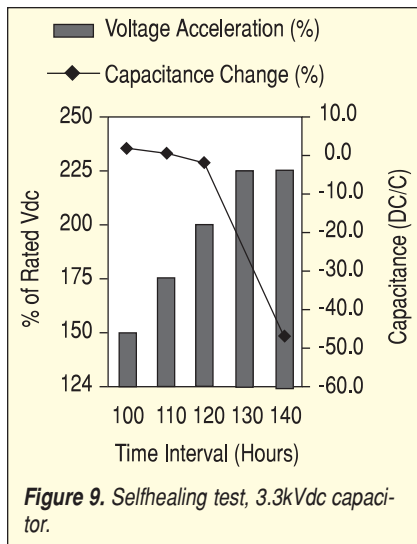

at 225% of the rated voltage. After eight hours at this step, the loss was about 25% on all samples. At 12 hours it was close to 40%, and at 16 hours it was close to a 50% reduction. After the 50% reduction in capacitance a bulge of 0.25 cm was detected in the sides of both samples, although this was not enough to activate either pressure switch.

References

1. Dr. Ing. Th. Schuerze, "Design Aspects for Inverters With IGBT High Power Modules," PCIM, August 1998 pp 2841.
2. M. Brarnouille, "An Alternative to Electrolytic Capacitors," PCIM Europe, 1996 Conference, pp 359363.
3. M. W. Carlen, P. Bruesch, "Electrical Endurance Characterization of Polypropylene Winding Capacitors For Traction Applications," Seventh International Conference on Dielectric Materials Measurements and Applications, pp 350355.
4. M. Held, P. Jacob, G. Nicoletti, P. Scacco, M. Poech, "Fast Power Cycling Test for IGBT Modules in Traction Application," 1997, IEEE International Conference on Power Electronics and Drive Systems.
5. Motto, E., "HVIGBT or GCT Which is Best?," PCIM, May 1999, pp 3644.
6. J. M. Peter, "New Devices Pursue Lower OnResistance, Higher Voltage Operation," PCIM, January 1999, pp 2431.
7. K. Harada, A. Katsuki, M. Fujiwara, "Use of ESR for Deterioration Diagnosis of Electrolytic Capacitor," IEEE Transactions on Power Electronics, October 1993, pp 355359.
8. W. J. Sarjeant, F.W. MacDougall, D.W.Larson, "Energy Storage in Polymer Laminate Structures Ageing and Diagnostic Approaches for Life Validation," IEEE Electrical Insulation Magazine, January/February 1997, pp 2024,
9. C.A. Nucci, S. Pirani and M. Rinaldi, "Pulse Withstand Capability Of Self Healing Metallized Polypropylene Capacitors in Power Applications," IEEE Transactions on Electrical Insulation, 26(1), pp. 146155, 1991.
10. H. Vetter, "Dry MKK Capacitors for Modern Rail Traction," 1998.
11. A. Schneuwly, P. Groning, L. Schlapbach, "Breakdown Behavior of OilImpregnated Polypropylene as Dielectric in Film Capacitors," IEEE Transactions on Dielectrics and Electrical Insulation, December 1998, pp 862866.
12. CEI/IEC 10711 199 1, International Standard, Power Electronic Capacitors, Part 1.